

MH118-1A



Motor Fin Mount Probe Pad, 0.5" x 1.25" (12.7 mm x 31.75 mm) Probe Tip

VIBRATION ANALYSIS HARDWARE



Product Features

Mounts conveniently between motor cooling fans with use of adhesive

- ▶ Attracts magnetic bases for portable measurements
- ▶ Epoxy Catch side textures
- ▶ Permanently installed with adhesive

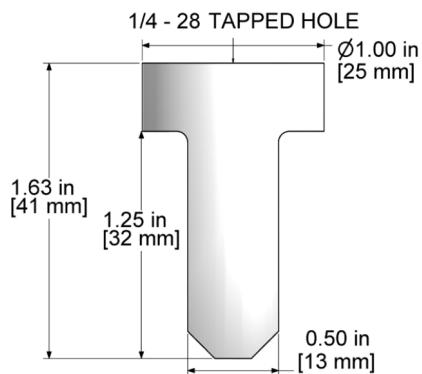

Specifications

Case Material	17-4 Stainless Steel
Sensor Mounting	1/4-28 Tapped Hole
Field Mounting	Epoxy (Sold Separately)
Recommended Epoxy	CTC MH109-2A Sold Separately
Protective Cover	CTC CP101-2A Red Cap Cover

Chemical Compatibilities for Reference

- ▶ Gasoline - A
- ▶ Methanol - A
- ▶ Lubricants - A

Compatibility

- ▶ Compatible with all sensors with 1/4-28 mounting stud or bolt
- ▶ Conversion mounting studs sold separately

Stock Product

Backed by our Unconditional Lifetime Warranty

www.ctconline.com | sales@ctconline.com | 585-924-5900